

3 1 2 3

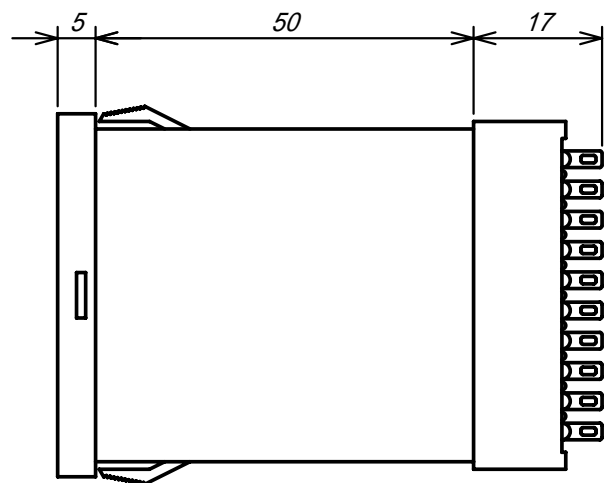
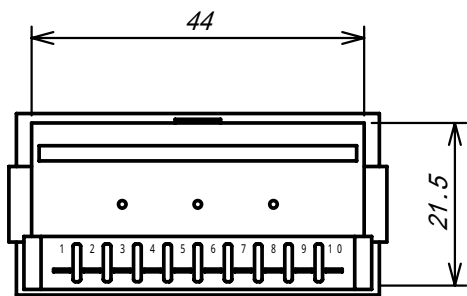
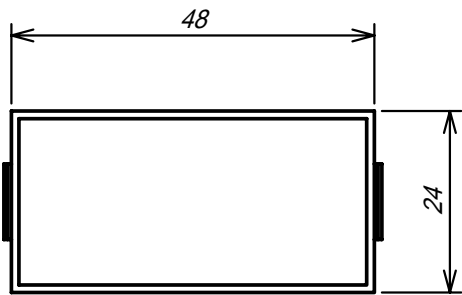

単位 : m m

パネルカット寸法 : $45^{+0.5}_0 \times 22.2^{+0.3}_0$