

SOCKET

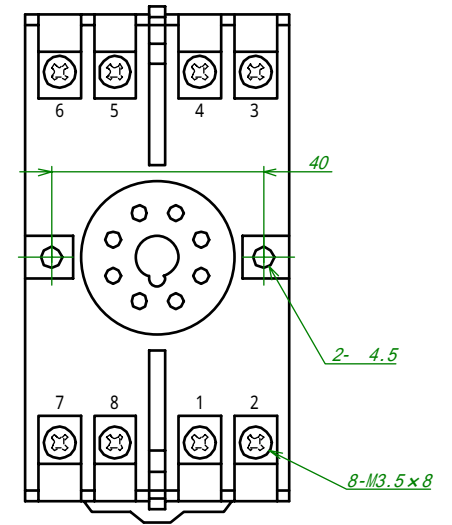

TSURUGA ELECTRIC CORPORATION. All rights reserved.

REVISED	DATE	APPROVED BY	TITLE 7512, 7513, 7514 7515, 7516, 7532 7552, 7562, 7564 7572, 7581, 7582
	SCALE	CHECKED BY	
	DESIGNED BY	DRAWN BY	
	TSURUGA ELECTRIC CORPORATION		

MODEL 7574 ONLY

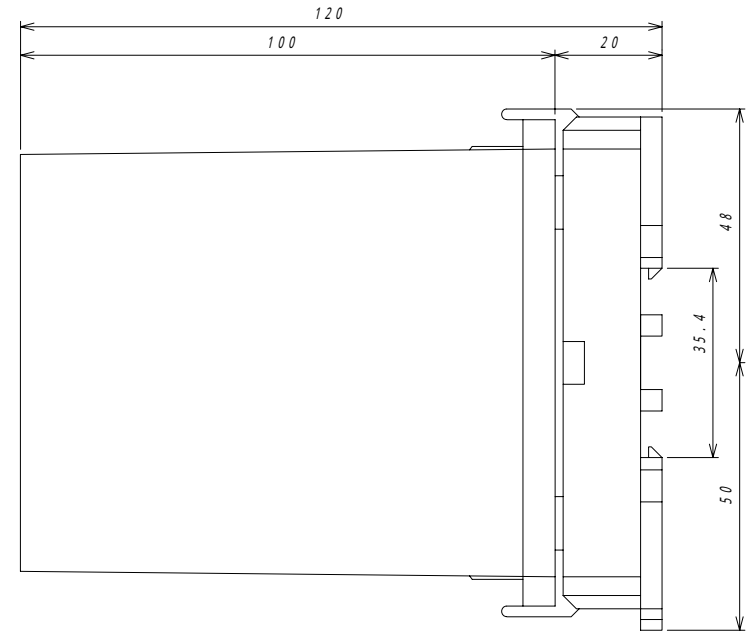
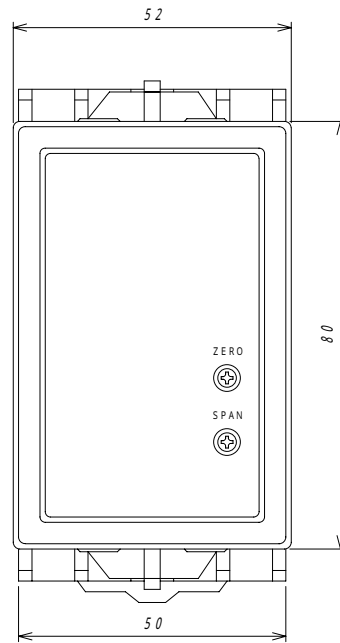
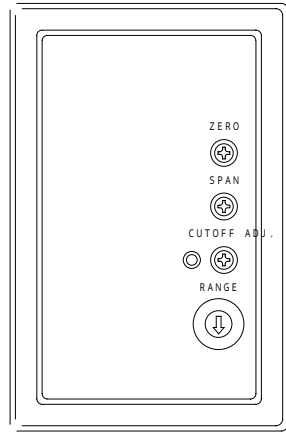

MODEL 7573 ONLY

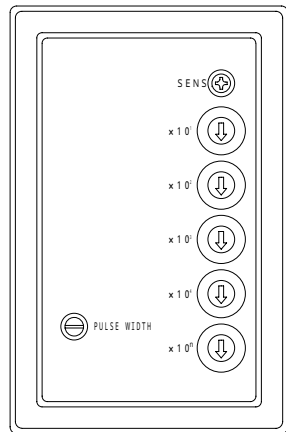

MODEL 7576 ONLY

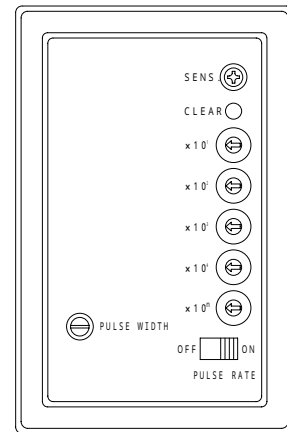

MODEL 7591 ONLY

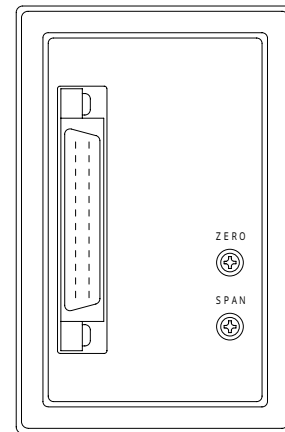

SOCKET

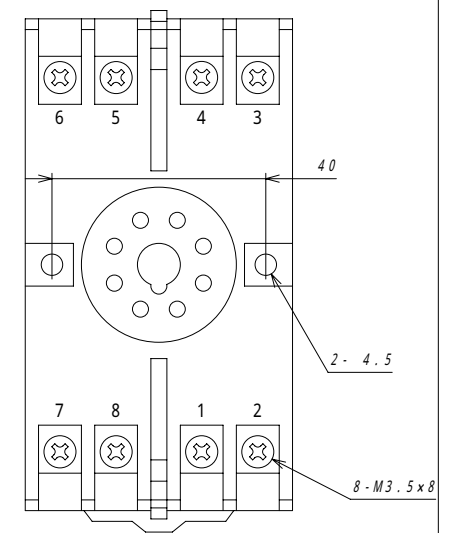

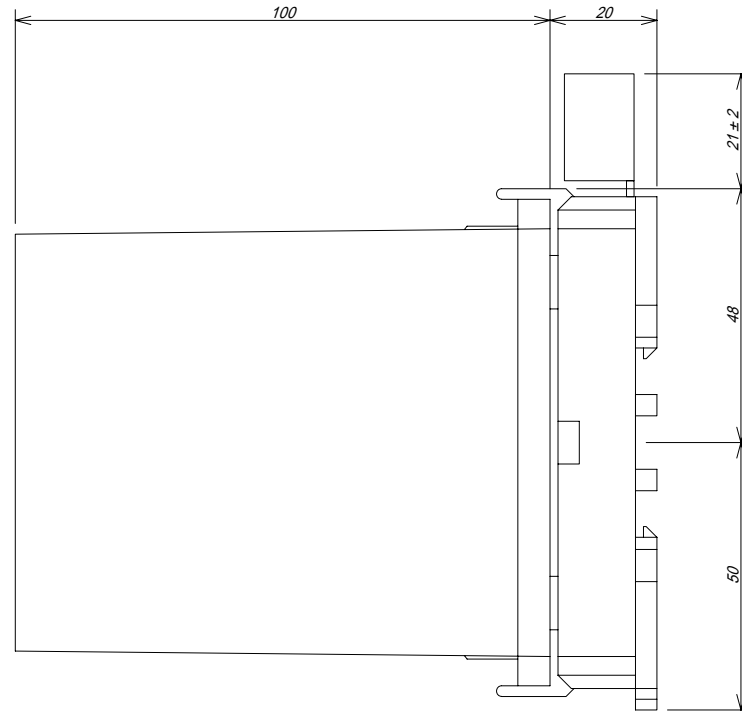
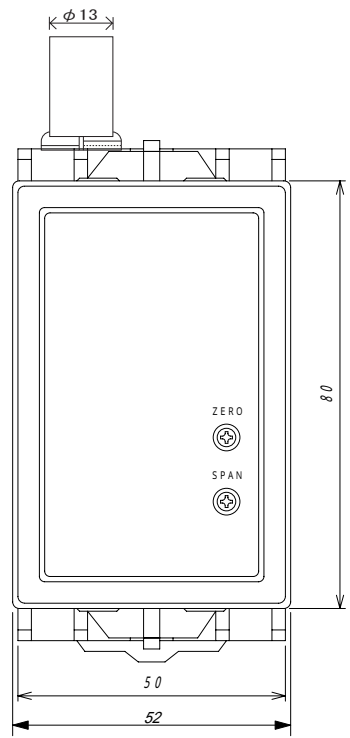

MODEL : 7522

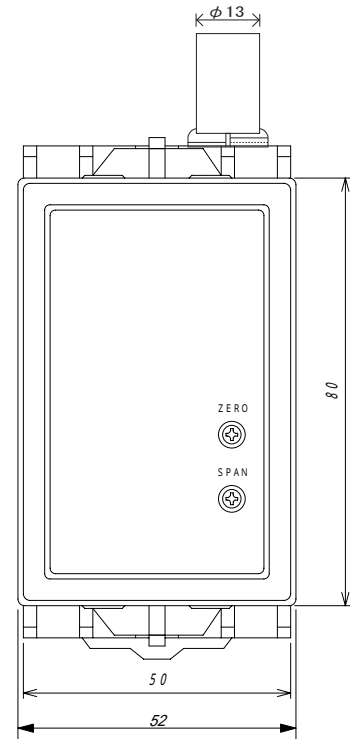
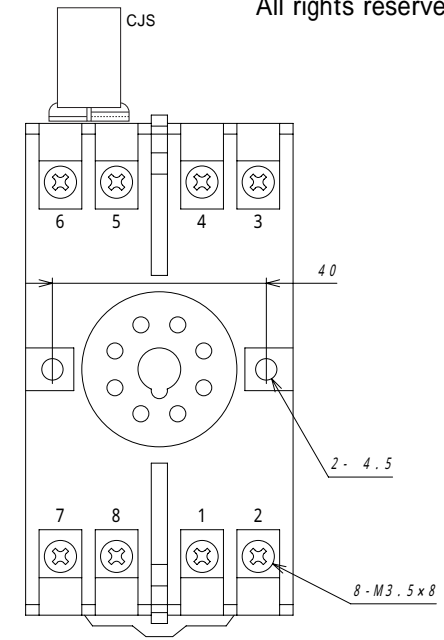

MODEL : 7541, 7542

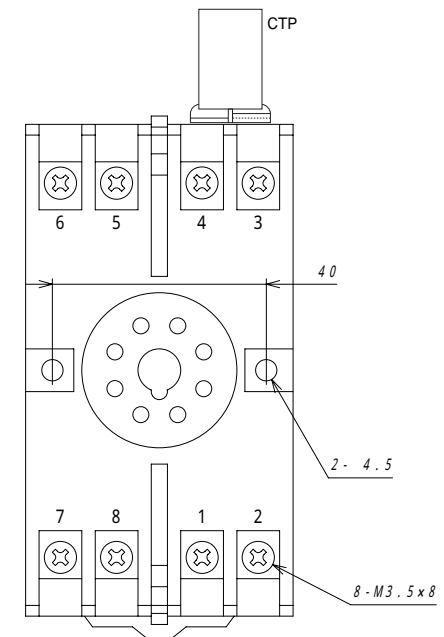

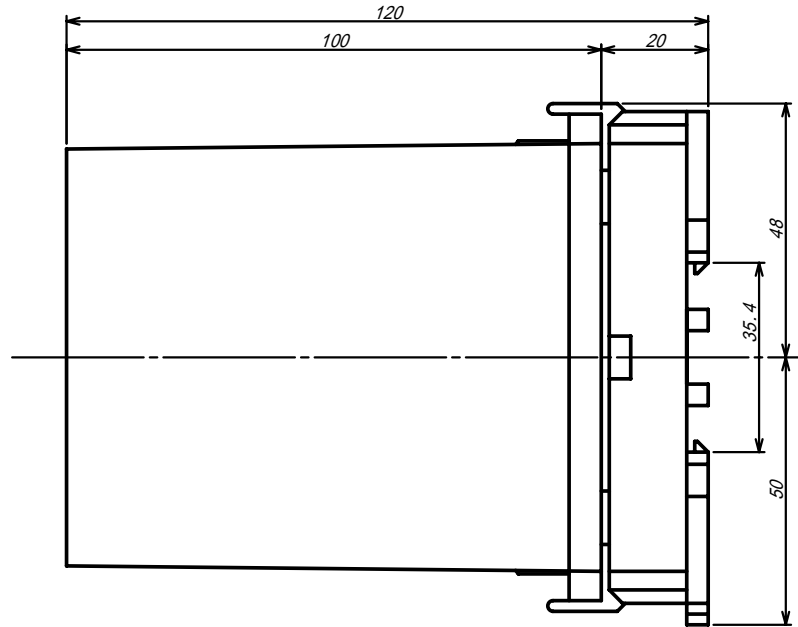
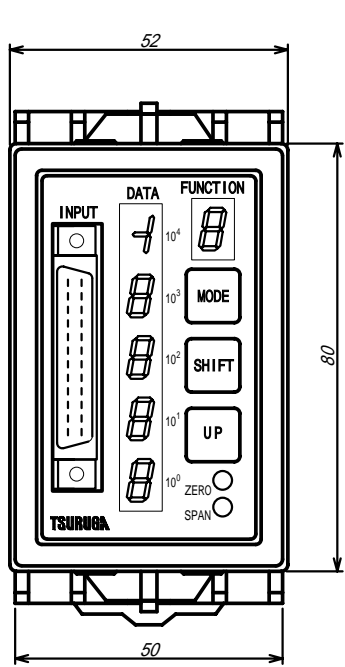

SOCKET

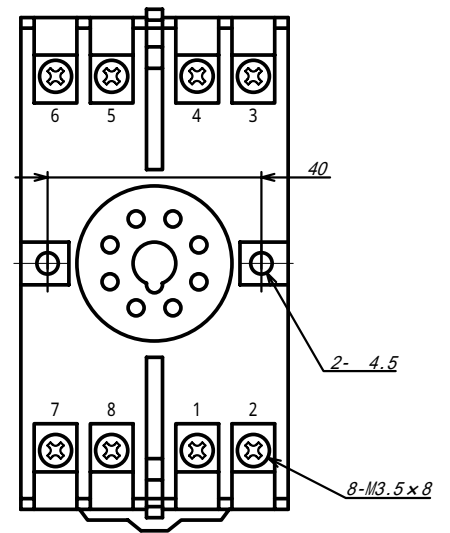

TSURUGA ELECTRIC CORPORATION. All rights reserved.

REVISED	DATE	APPROVED BY	TITLE 7592
	SCALE	CHECKED BY	
	DESIGNED BY	DRAWN BY	
	TSURUGA ELECTRIC CORPORATION		
DRAWING No.			